



the new premium scanning standard

excelliSCAN scan heads set new standards for the most demanding laser scanning requirements. As SCANLAB 2D scan systems, they enable deflecting and positioning of laser beams in the working plane.

SCANahead control

- Full utilization of scanner dynamics for higher throughput
- No unwanted necking effects when rapidly processing circles
- Universal tuning optimized for all applications

dynAXIS_{se} digital-encoder galvanometers

- Maximum linearity and minimum position noise ensure highest positioning accuracy
- High long-term stability even with ambient temperature fluctuations and 24/7-operation

Its groundbreaking SCANahead control technology attain previously unreachable dynamic performance and precision. This translates to enormous gains in productivity and process accuracy.

Housing innovations

- Enhanced thermal management for higher load resilience
- Variant with active air cooling available for applications that don't allow water as a coolant
- Increased tightness (IP56) and robustness

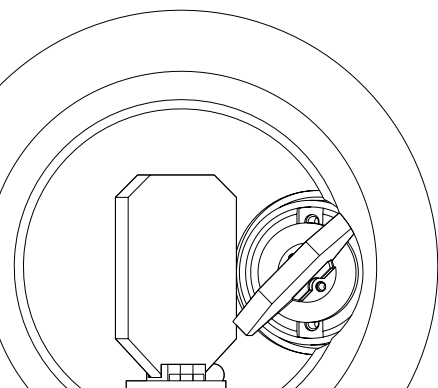

SCANahead control

SCANahead principle of operation

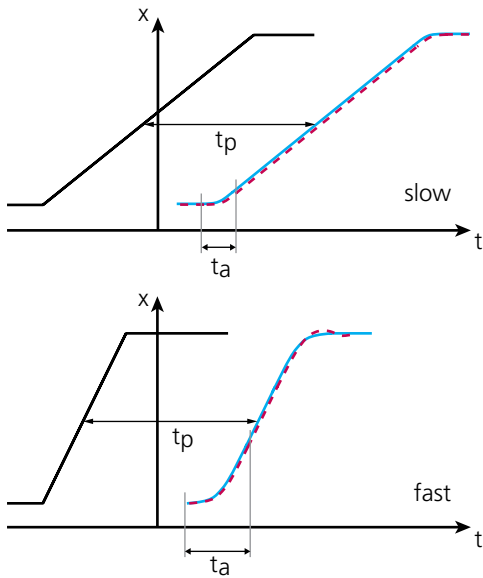

Conventional control

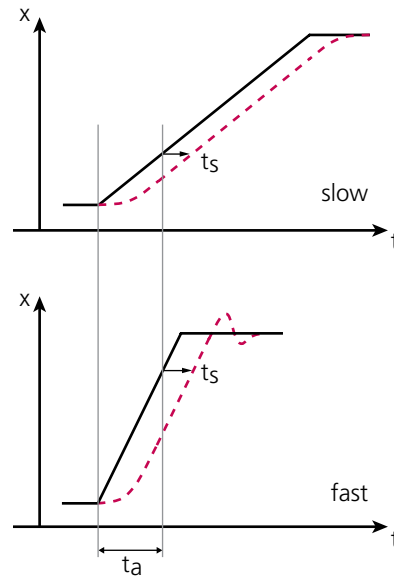

SCANahead control allows excelliSCAN to deliver **full acceleration** even at slow scan speeds (i.e. with minimum acceleration duration t_a). Pre-computed set-point trajectories make this possible. Computation occurs in real time, offset by the look-ahead time t_p , prior to actual execution.

Limiting trajectory acceleration to the scanner axes' full acceleration produces a set-point trajectory (blue curve) that the SCANahead control can track without tracking error (red curve). Thus, the galvos' dynamic performance potential is optimally utilized.

In contrast, **conventional** control is afflicted with a constant tracking error t_s , independent of scan speed. Likewise constant is the acceleration duration t_a until reaching the intended scan speed.

The higher the maximum speed, the higher the tracking error and longer the acceleration duration. As maximum speed goes up, the scan axes' acceleration potential gets decreasingly utilized at low scan speeds.

Application Benefits

Enhanced accuracy

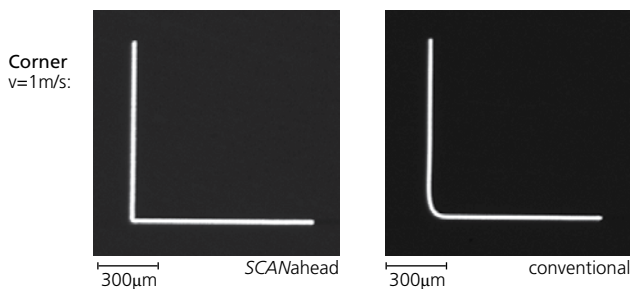

SCANahead control fully exploits the galvos' dynamic performance potential. Hence traversal of 90° corners at a wide range of speeds produces far less corner-rounding. Additionally, SCANahead allows faster traversal of corners having identical radii.

In contrast, traditional control with tracking error may cause substantial corner rounding – speed-dependent and if no delays were implemented.

Fast and precise circle processing

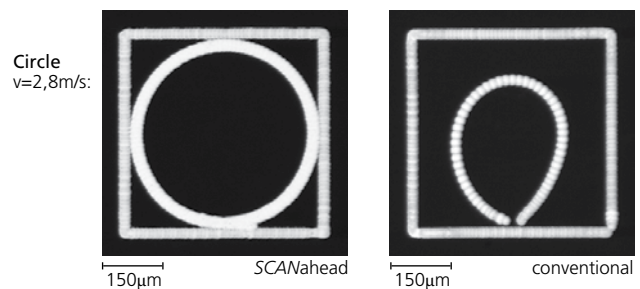

SCANahead control ensures precise traversal of the defined set circle even at high circle speeds. This substantially simplifies correct processing of circles and boosts productivity thanks to increased trajectory velocities.

In contrast, tracking errors of traditional scanner control produce a necking effect during high-speed circle traversal. The control effectively behaves as a low-pass filter that attenuates control-signal amplitudes at high circle frequencies.

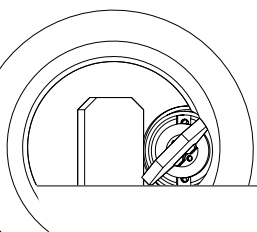

	SCANahead control	Conventional control
Dynamics	<ul style="list-style-type: none"> • Scanner axis acceleration always at maximum: acceleration time is minimized. 	<ul style="list-style-type: none"> • Acceleration time is constant at all scan speeds: acceleration potential isn't fully utilized.
Processing circles, arcs	<ul style="list-style-type: none"> • Necking effects avoided. 	<ul style="list-style-type: none"> • Necking effects (caused by tracking error) need to be offset by adjusting circle diameters.
Tracking error	<ul style="list-style-type: none"> • Concept fundamentally eliminates it. • Precise image field correction even at high speeds • Only one tuning needed. Optimum performance across all applications. • A uniform look-ahead time t_p is used to determine the navigable trajectory. 	<ul style="list-style-type: none"> • Finite, constant value • Limits precision of image field correction at high speeds • Optimized typically for a single application. Digital scan systems allow a variety of tunings.
Use of delays	<ul style="list-style-type: none"> • Auto-delay eliminates the need to set delays for high-quality results. 	<ul style="list-style-type: none"> • Need to be set in advance • User must monitor processing results and needs to optimize delay settings iteratively.

Control via RTC6

Equipped with expanded memory and a high-performance DSP and FPGA, the new RTC6 enables powerful applications and is ready for future functional extensions.

When synchronously controlling the excelliSCAN and a laser, the RTC6 board takes into account the SCANahead control's look-ahead time (used for computing scanner trajectories) so as to optimally utilize dynamic performance and accuracy. The RTC6's auto-delay functionality facilitates simple, fast excelliSCAN deployment. This frees users from needing to determine or define laser and scanner delays.

Innovative Housing

- Robust, tight shell construction
- Two cooling variants available:
 - Water cooling for maximum cooling performance
 - Active air cooling with innovative heat-pipe technology for applications that prohibit using water coolant
- Air-cooling connection for mirrors (standard)
- Broad assortment of objectives available, thanks to proven standard interface
- Electrical connections can be positioned at either the beam entrance or opposite to the beam exit side

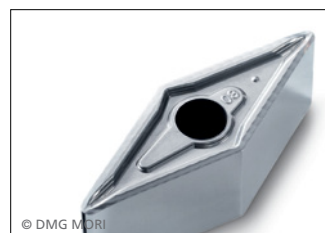
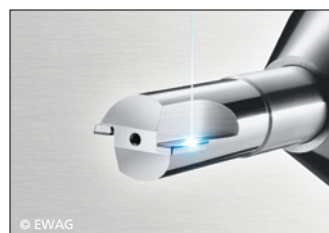
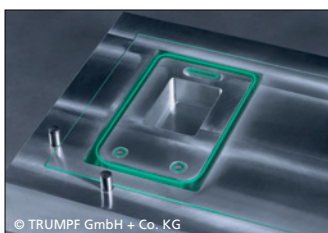

Specifications

Dynamics

	excelliSCAN 14
Aperture [mm]	14
Tuning	universal
Tracking error [ms]	0
Typical speeds ⁽¹⁾	
Positioning, jump & shoot [m/s]	< 30
Line scan / raster scan [m/s]	< 30
Typical vector marking [m/s]	< 4
Good writing quality [cps]	1000
High writing quality [cps]	850
Positioning times ⁽¹⁾	
1 mm jump width [ms]	0.28
10 mm jump width [ms]	0.88
100 mm jump width [ms]	3.70
Acceleration [m/s ²]	51 000 ^{(1),(2)}

⁽¹⁾ with F-Theta objective, f = 160 mm

⁽²⁾ this corresponds to an angular acceleration of 3.2·10⁵ rad/s²

Precision & Stability

	excelliSCAN
Repeatability (RMS) [μrad]	< 0.4
Positioning resolution [bit]	20 ⁽⁵⁾
Nonlinearity	< 0.5 mrad / 44°
Long-term drift ^{(3), (4)}	
8-h-drift (after 30 min warm-up)	
Offset [μrad]	< 20
Gain [ppm]	< 20
24-h-drift (after 3 h warm-up)	
Offset [μrad]	< 20
Gain [ppm]	< 25
Temperature drift ⁽⁴⁾	
Offset [μrad/K]	< 10
Gain [ppm/K]	< 4

⁽³⁾ at constant ambient temperature and load

⁽⁴⁾ with water cooling

⁽⁵⁾ based on the full angle range (e.g. positioning resolution 0.7 μrad for angle range ± 0.36 rad)

Further Specifications

	excelliSCAN
Optical performance	
Typical scan angle [rad]	±0.35
Gain error [mrad]	< 5
Zero offset [mrad]	< 5
Power requirements	30 V DC, max. 3 A
Interface	SL2-100
Operating temperature [°C]	25 °C ± 10 °C
Weight [kg]	approx. 7

(all angles are in optical degrees)

SCANcalc App



Google Play

iTunes

Options & Variants

Housing Variants

- Air and water cooling
- Active air cooling on request (heat-pipe technology)

Extensions

- excelliSHIFT: Extension into a high-speed 3-axis scan system
- varioSCAN: Extension into a 3-axis scan system
- Camera adapter for process monitoring

Optics

- Coatings for the following wavelengths are currently available: 355 nm, 532 nm and 1064 nm
- Suitable objectives available for various image fields and focal lengths

Control Boards/Software

- RTC6 (PCIe und Ethernet) with SCANahead servo control
- laserDESK: professional software for laser marking and materials processing
- SCANalign: software for automatic and exact placement of the laser beam to a workpiece; process integrable high-precision calibration solution
- Flexible calibration solutions: correXion pro, CALsheet

Housing variants

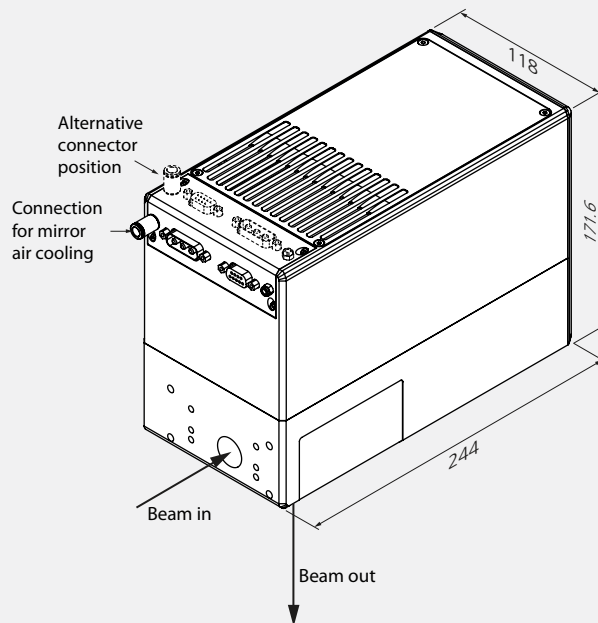
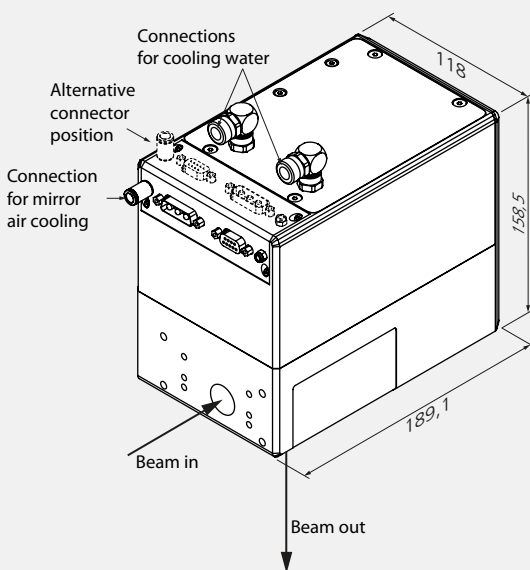

all dimensions in mm

05/2018 information is subject to change without notice. Product photos are non-binding and may show customized features.